

# DOCCIAPIETRA H2 PIATTO DOCCIA DP214090XXX

CE EN 14527:2016

DIN 51097

Resistenza allo scivolamento con angolo 24° secondo DIN51097

# GLOBO

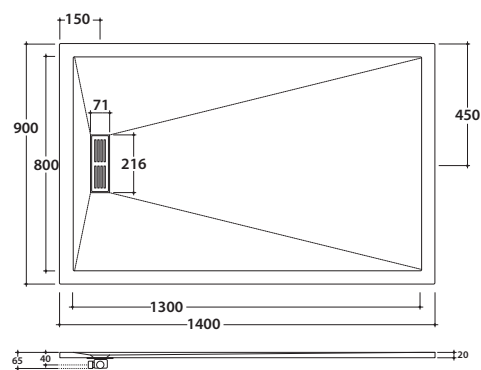

Cod. **DP214090XXX**

Piatto doccia 140x90 cm. Installazione da appoggio o filo pavimento.

Piletta di scarico inclusa. Reversibile. Peso 34,2 Kg

## Colori



506 Bianco



507 Grigio



508 Beige



509 Nero



510 Tortora

## Ricambi



Cod. **DP011XXX**

Copripiletta



Cod. **DP012**

Piletta di scarico

## Accessori



Cod. **DET01**

Detergente per pulizia dei piatti doccia DOCCIAPIETRA (1 Lt)



Cod. **DPPENXXX**

Pennarello di ritocco



Cod. **DPKITXXX**

Kit di riparazione