

# STRIPE STRUTTURA A TERRA OP080S

# GLOBO



Cod. **OP080SXX**

Finiture



Nero opaco  
**AR**

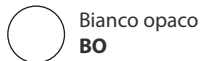

Bianco opaco  
**BO**

Struttura a terra in acciaio verniciato a polvere 80x47 h78 cm. Peso 19,4 Kg.

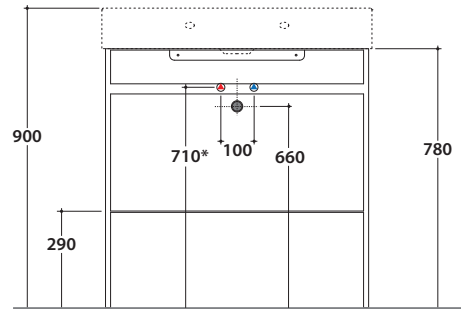
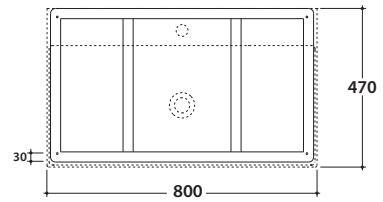

\* Per rubinetto su piano

# STRIPE PIANO IN VETRO OP041S

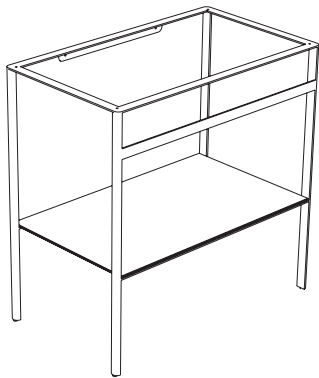

Cod. **OP041SXX**

Finiture



Nero opaco  
**AR**

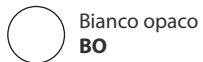

Bianco opaco  
**BO**

Piano in vetro retroverniciato 74,6x45,2 h 0,6 cm. Peso 5 Kg.

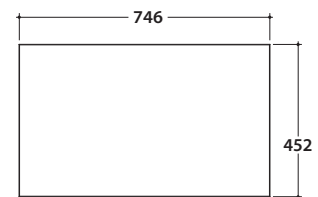

lavabi compatibili

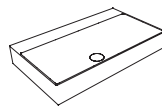

B6R81

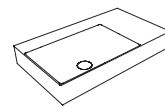

B6R80S

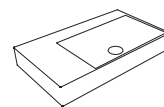

B6R80D

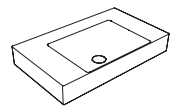

B6R82