

# MARÍ Base portalavabo sospesa h 36,8 cm MR3695

# GLOBO

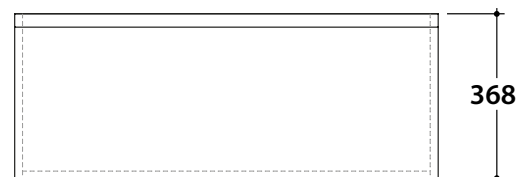
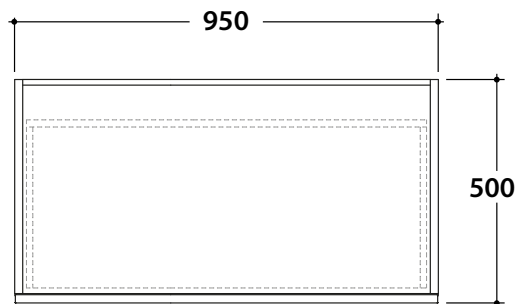
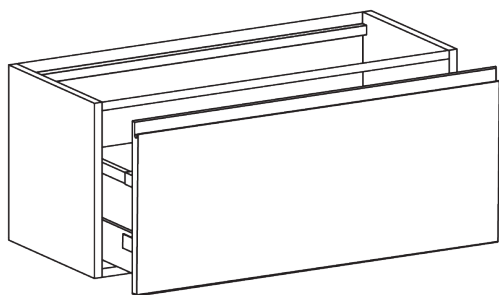

## Finiture disponibili

**Categoria 1**  
Melaminico termostrutturato

**Categoria 3**  
Laccati opachi

Legno Friuli  
LF

Legno Badia  
LD

Bianco opaco  
BO

Sabbia  
SI

London  
LN

Cipria  
CI

## Lavabi disponibili per installazione a consolle

	A	B*	C	D	E
**SCQ82	845	660	600	770	280
**SCQ92	845	660	600	770	280

B\* Per rubinetteria su piano

\*\* Quote per Composizione 3 e 4

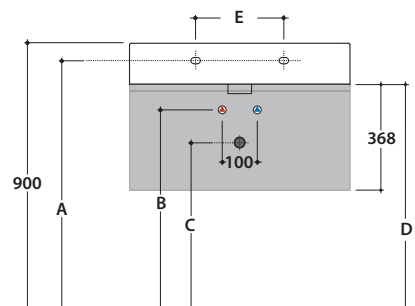

## Lavabi da appoggio su top Hoja

	A*	B	C**		A*	B	C**
B6T30	650	600	740	FO054	670	620	760
B6T37	650	600	740	B6R56	650	600	740
B6Q38	650	600	740	B6R55	680	610	780
B6T42	650	600	740	B6O62	650	600	740
B6Q43	650	600	740	TFO60	650	600	740
B6Q42	670	620	760	TFO61	650	600	740
B6T45	650	600	740	B6O60	650	600	740
B6Q45	650	600	740	B6R60	650	600	740
B6T48	650	600	740	FO062	670	620	760
B6O50	650	600	740	B6R63	670	620	760
FO050	670	620	760	B6R65	680	610	780
B6R53	650	600	740	B6O65	650	600	740
B6R54	670	620	760	B6R66	680	610	780
B6R51	680	610	780	B6R70	680	610	780
B6O54	650	600	740	B6R81	680	610	780
TE055	670	620	760	B6R100	680	610	780

A\* Per rubinetteria su piano

C\*\* La quota C è comprensiva di top quindi considerare lo spessore del top Hoja scelto in base alla finitura

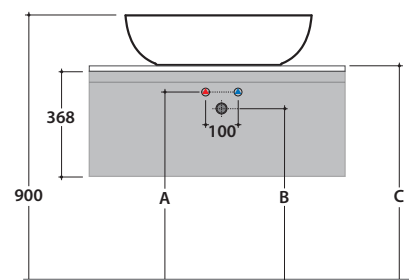

Esempio :  
Lavabo B6O62

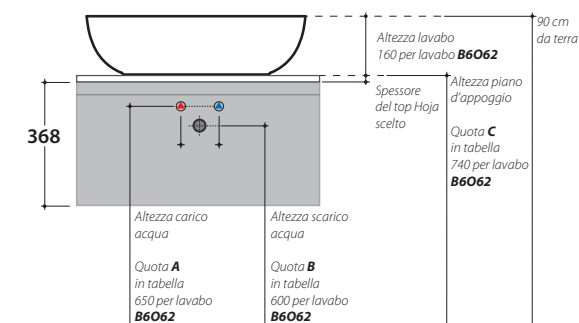

# MARÍ Base portalavabo sospesa h 36,8 cm MR3695

# GLOBO

## Lavabi integrati

BL096BI  
96x51

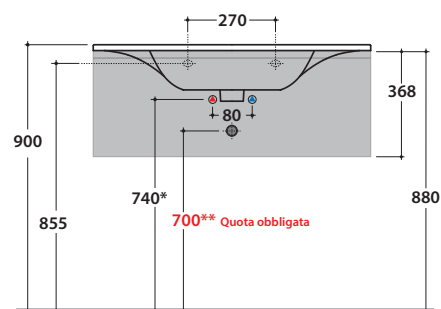

\* Per rubinetteria su piano

\*\* Quota obbligata con sifone GLOBO cod. **RA054CR**

Utilizzare la vite di fissaggio, per la piletta **FI012BI**, inclusa nel sifone cod. **RA054CR**