

DOCCIATRE PLUS DTP140

CE EN 14527:2019

DIN 51097

Slip resistance at an angle of 22,2° according DIN51097

GLOBO

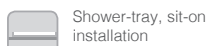
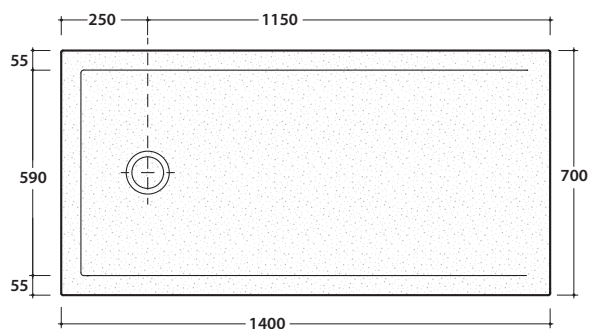

Shower-tray, sit-on installation



Shower-tray, floor-level installation



Shower tray with non slip finish



Cod. **DTP140**

Rough stone effect shower tray 140x70 h3 cm in ceramic. No-slip surface. Sit-on or floor-level installation. Weight 36 Kg.



Cod. **DS009**

Siphoned chrome drain for shower trays DOCCIAVIVA H 4,5, DOCCIATRE and DOCCIATRE PLUS. \varnothing 90. Discharge flow rate 30 l/m.



Cod. **DVR2**

Siphoned drain with ceramic cover for shower trays DOCCIAVIVA H 4,5 and DOCCIATRE. \varnothing 90. Discharge flow rate 30 l/m.

* Availability of colours

Code | Colour

BP Bianco pietra



GP Grigio pietra



NP Nero pietra

