

# DOCCIATRE PLUS DTP101BP

CE EN 14527:2019

DIN 51097

Slip resistance at an angle of 22,2° according DIN51097

# GLOBO

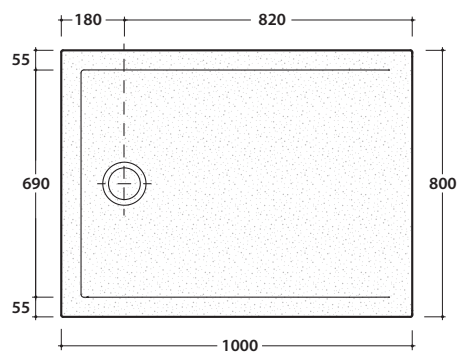

Shower-tray, sit-on installation



Shower-tray, floor-level installation



Shower tray with non slip finish

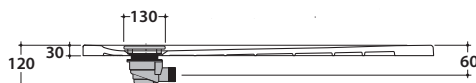

Cod. **DTP101BP**

Rough stone effect shower tray 100x80 h3 cm in ceramic. No-slip surface. Sit-on or floor-level installation. Weight 26 Kg.



Cod. **DS009**

Siphoned chrome drain for shower trays DOCCIAVIVA H 4,5, DOCCIATRE and DOCCIATRE PLUS.  $\varnothing$  90. Discharge flow rate 30 l/m.



Cod. **DVR2BP**

Siphoned drain with ceramic cover for shower trays DOCCIAVIVA H 4,5 and DOCCIATRE.  $\varnothing$  90. Discharge flow rate 30 l/m.

## \* Availability of colours

Code | Colour

BP | Bianco pietra

